

**LUDLUM MODELS 2401-ECA,  
2401-EWA, 2401-EC2A AND 2401-PA  
POCKET SURVEY METERS WITH ALARM**

**November 2019**

**Serial Number 143446 and Succeeding  
Serial Numbers**

**LUDLUM MODELS 2401-ECA,  
2401-EWA, 2401-EC2A AND 2401-PA  
POCKET SURVEY METERS WITH ALARM**

**November 2019**

**Serial Number 143446 and Succeeding  
Serial Numbers**



**LUDLUM MEASUREMENTS, INC**  
501 OAK STREET, P.O. BOX 810  
SWEETWATER, TEXAS 79556  
325-235-5494, FAX: 325-235-4672

## **STATEMENT OF WARRANTY**

Ludlum Measurements, Inc. warrants the products covered in this manual to be free of defects due to workmanship, material, and design for a period of twelve months from the date of delivery. The calibration of a product is warranted to be within its specified accuracy limits at the time of shipment. In the event of instrument failure, notify Ludlum Measurements to determine if repair, recalibration, or replacement is required.

This warranty excludes the replacement of photomultiplier tubes, G-M and proportional tubes, and scintillation crystals which are broken due to excessive physical abuse or used for purposes other than intended.

There are no warranties, express or implied, including without limitation any implied warranty of merchantability or fitness, which extend beyond the description of the face there of. If the product does not perform as warranted herein, purchaser's sole remedy shall be repair or replacement, at the option of Ludlum Measurements. In no event will Ludlum Measurements be liable for damages, lost revenue, lost wages, or any other incidental or consequential damages, arising from the purchase, use, or inability to use product.

## **RETURN OF GOODS TO MANUFACTURER**

If equipment needs to be returned to Ludlum Measurements, Inc. for repair or calibration, please send to the address below. All shipments should include documentation containing return shipping address, customer name, telephone number, description of service requested, and all other necessary information. Your cooperation will expedite the return of your equipment.

**LUDLUM MEASUREMENTS, INC.  
ATTN: REPAIR DEPARTMENT  
501 OAK STREET  
SWEETWATER, TX 79556**

**800-622-0828 325-235-5494  
FAX 325-235-4672**

REV #	ALTERATIONS	DATE	BY
1	VALID	11-6-97	JGW
2	ADDED CE MARK	9-15-05	CMC
3	ADDED SYMBOLS	04/24/06	PW
4	SCALED "DISCARD" SYMBOL DOWN BY 1/2	4/13/11	CMC

+

0 mR/hr 0.5 1.0 1.5 2.0  
0 CPM 500 1K 1.5K 2K

**M** LUDLUM MEASUREMENTS, INC.  
SWEETWATER, TEXAS

**MODEL 2401-ECA**  
**SURVEY METER**

○ ALARM

○ QUIET  
○ NORMAL  
○ BAT CHECK OFF

X1 X10 X100

⚠

X1 X10 X100 ALARM

**CE**

+

0 mR/hr 0.5 1.0 1.5 2.0  
0 CPM 500 1K 1.5K 2K

**M** LUDLUM MEASUREMENTS, INC.  
SWEETWATER, TEXAS

**MODEL 2401-EWA**  
**SURVEY METER**

○ ALARM

○ QUIET  
○ NORMAL  
○ BAT CHECK OFF

X1 X10 X100

⚠

X1 X10 X100 ALARM

**CE**

+

0 mR/hr 5 10 15 20  
0 CPM 100 200 300 400 500

**M** LUDLUM MEASUREMENTS, INC.  
SWEETWATER, TEXAS

**MODEL 2401-EC2A**  
**SURVEY METER**

○ ALARM

○ QUIET  
○ NORMAL  
○ BAT CHECK OFF

X1 X10 X100

⚠

X1 X10 X100 ALARM

**CE**

+

0 mR/hr 0.05 0.10 0.15  
0 CPM 100 200 300 400 500

**M** LUDLUM MEASUREMENTS, INC.  
SWEETWATER, TEXAS

**MODEL 2401-PA**  
**SURVEY METER**

○ ALARM

○ QUIET  
○ NORMAL  
○ BAT CHECK OFF

X1 X10 X100

⚠

X1 X10 X100 ALARM

**CE**

DWN DATE CMC 4-13-11	CHECKED	APPROVED <i>BSB</i>
TITLE: M 2401 SERIES WITH ALARM		
<b>M</b> LUDLUM MEASUREMENTS, INC. 501 DMC STREET SWEETWATER, TEXAS 75086	SERIES 397	SHEET 98

# Table of Contents

---

<b><i>Introduction</i></b>	<b>1</b>
<b><i>Getting Started</i></b>	<b>2</b>
<b>Battery Installation</b>	<b>2-1</b>
<b>Battery Test</b>	<b>2-1</b>
<b>Instrument Test</b>	<b>2-1</b>
<b>Operational Check</b>	<b>2-2</b>
<b><i>Specifications</i></b>	<b>3</b>
<b><i>Identification of Controls and Functions</i></b>	<b>4</b>
<b><i>Safety Considerations and Maintenance</i></b>	<b>5</b>
<b>Environmental Conditions for Normal Use</b>	<b>5-1</b>
<b>Warning Markings and Symbols</b>	<b>5-1</b>
<b>Mica Window Precaution</b>	<b>5-2</b>
<b>Cleaning and Maintenance Precautions</b>	<b>5-2</b>
<b>Maintenance</b>	<b>5-3</b>
<b>Recalibration</b>	<b>5-3</b>
<b>Slide Switches</b>	<b>5-3</b>
<b><i>Radiation Basics</i></b>	<b>6</b>
<b>Radiation and Life</b>	<b>6-1</b>
<b>The Unstable Atom</b>	<b>6-2</b>
<b>Radioactive Decay</b>	<b>6-3</b>
<b>Ionizing Radiation</b>	<b>6-4</b>
<b>Measuring Ionizing Radiation</b>	<b>6-5</b>
<b>What are the Health Risks from Ionizing Radiation?</b>	<b>6-6</b>
<b>How Much Ionizing Radiation is Dangerous?</b>	<b>6-7</b>
<b>Background Radiation</b>	<b>6-10</b>
<b>Manmade Radiation</b>	<b>6-11</b>
<b>Protection from Radiation</b>	<b>6-11</b>
<b>Standards and Regulation</b>	<b>6-12</b>
<b>Who is in Charge?</b>	<b>6-12</b>

<b><i>Recycling</i></b>	<b>7</b>
<b><i>Parts List</i></b>	<b>8</b>
<b>Models 2401-ECA, 2401-EWA, 2401-EC2A Survey Meters</b>	<b>8-1</b>
<b>Main Board, Drawing 397 × 87</b>	<b>8-1</b>
<b>Model 2401-PA Survey Meter</b>	<b>8-4</b>
<b>Main Board, Drawing 397 × 190</b>	<b>8-4</b>
<b><i>Drawings and Diagrams</i></b>	<b>9</b>

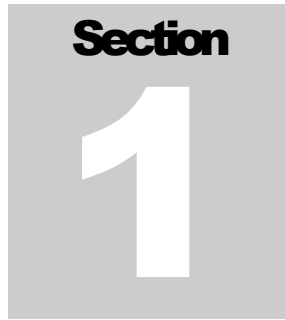
A gray square graphic with the word "Section" in bold black text at the top and a large white number "1" in the center.

## Introduction

---

The Model 2401 alarming series of hand-held or “pocket” radiation survey instruments are designed to quickly and easily measure ionizing radiation. Different types are available featuring different internal detectors. These types are distinguished from one another by a suffix following the “Model 2401” designation. The units are self-contained and require no external accessories.

This manual applies to the following instruments in the Model 2401 Series of Pocket Radiation Survey Meters with Alarm:

**Model 2401-ECA** - contains an energy-compensated Geiger-Mueller (GM) tube detector, which measures low levels of gamma radiation. One or two measurement scales are provided on the meter face (in addition to the BAT OK range). If two scales are provided, they indicate exposure rate and count rate. Examples of exposure rate units are mR/hr and mSv/h, while count rate may be measured in counts per minute (cpm) or counts per second (cps).

**Model 2401-EWA** - has a thin end-window, GM tube detector that measures alpha, beta, and gamma radiation. The mica window has a thickness (window area density) of 1.5 to 2.0 mg/cm<sup>2</sup>. Two measurement scales may be provided on the meter face as described above.

**Model 2401-EC2A** - contains an energy-compensated GM tube detector. This is basically the same as the Model 2401-ECA, with the capability of measuring higher levels of gamma radiation with corresponding measurement scales.

**Model 2401-PA**- employs a full-size “pancake” tube detector (5.1 cm {2 in.} diameter) that can measure alpha, beta, and gamma radiation. One or two measurement scales may be provided on the meter face in units of exposure rate and/or count rate as described above.

Each instrument in the Model 2401 series has a large 6.4 cm (2.5 in.) analog meter for displaying the radiation level. A three-decade range switch allows the user to switch among the three ranges ( $\times 1$ ,  $\times 10$  and  $\times 100$ ). A BAT CHECK position on the selector switch allows the meter to show the battery level. A QUIET position allows the user to turn the click-per-event audio off. Activation of a red ALARM LED and steady tone from the audio speaker indicate an alarm condition when the displayed radiation level has exceeded the set alarm point.

A 9-volt battery powers the unit. Battery life is typically 250 hours at normal background levels. A steady tone from the audio speaker (whether in NORMAL or QUIET mode) indicates that the battery needs to be changed; proper instrument operation is not guaranteed until the battery is replaced.



**Section****2**

## Getting Started

---

### Battery Installation

Ensure the instrument selector switch is in the OFF position. Remove the four screws from the back side of the instrument and remove the back housing. Place a 9-volt battery in the battery holder and press the battery onto battery terminals. Replace the instrument housing and screws.

**Caution!**

Damage to the mica window on the top of the Model 2401-EWA and on the back side of the Model 2401-PA may result if careful instrument handling is not practiced. The window is very fragile and may be punctured quite easily.

### Battery Test

The battery should be checked each time the instrument is turned on. Slide the selector switch to the BAT CHECK position. Ensure that the meter needle deflects to the battery check portion on the meter scale. If the meter does not respond, check to see if the battery has been correctly installed. Replace the battery if necessary.

### Instrument Test

After checking the battery, slide the instrument selector switch to the NORMAL position. Slide the range switch to the  $\times 1$  position. A small meter needle deflection will likely occur due to normal background radiation. If the meter needle deflects past full-scale slide the range switch to the next highest range until a reading can be determined. The amount of deflection will depend upon the particular series of instrument (due to meter scale differences) and the amount of normal background radiation. The instrument speaker should emit a frequency (clicks) relative to the increase in meter reading.

Please set the alarm point(s) on this instrument to conform to your requirements. The factory-set alarm points may be incorrect for your use.

Refer to the instrument manual for more information on setting alarm points.

**FAILURE TO RESET THE ALARM POINT(S)  
MAY RESULT IN EXCESSIVE ALARMS OR  
LACK OF SENSITIVITY.**

Read and then remove the sticker (illustrated to the left) from the instrument. Setting of the alarm point is described in Section 4 of this manual. The factory setting of the alarm point is noted on the calibration sheet provided with the instrument.

Place the instrument selector switch in the QUIET position and note that the audible clicks are silenced. In order to preserve battery life, it is recommended that the instrument selector switch be kept in the QUIET position when the audio function is not needed.

While in an area of normal background radiation, expose the center of the detector to a check source. Ensure the check source reading is within 20% of the reference reading obtained during the last calibration.

**Note:**

The crosshairs above the meter on the black, front panel indicate the location of the center of the detector. The exception to this is with the Model 2401-P where the center of the detector is visible on the back side of the instrument.

If possible, and if not already activated in the previous step, place the range switch in the  $\times 1$  position and check for proper function of the alarm indicators by placing the check source in such a way as to drive the meter needle above the alarm set point.

Once this procedure has been completed, the instrument is ready for use.

## Operational Check

To assure proper operation of the instrument between calibrations and periods of nonuse, an instrument operational check, including battery test and instrument test (as described above), should be performed prior to use. A reference reading with a check source should be obtained at the time of initial calibration, or as soon as possible, for use in confirming proper instrument operation. In each case, ensure a proper reading on each scale. If the instrument fails to read within 20% of a proper reading, it should be sent to a calibration facility for recalibration.

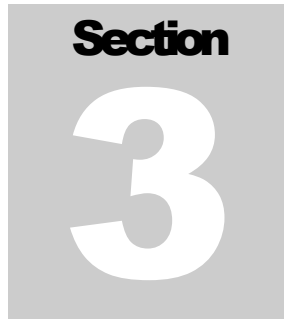
A gray square containing the word "Section" in a bold, black, sans-serif font at the top, and a large, white, bold number "3" in the center.

## Specifications

---

**Detector Tubes:** GM tubes with different characteristics for various models, as follows:

Model 2401-ECA: energy-compensated tube; gamma

Model 2401-EWA: end-window tube; alpha, beta, gamma

Model 2401-EC2A: energy-compensated tube; gamma

Model 2401-PA: standard 5.1 cm (2 in.) diameter pancake tube; alpha, beta, gamma

**Sensitivity:** typical values with a  $^{137}\text{Cs}$  source, as follows:

Model 2401-ECA: 1050 cpm per mR/hr

Model 2401-EWA: 1050 cpm per mR/hr

Model 2401-EC2A: 100 cpm per mR/hr

Model 2401-PA: 3300 cpm per mR/hr

**Energy Response:**

Model 2401-ECA: within 20% of true value from 60 keV to 3 MeV

Model 2401-EWA: energy dependent

Model 2401-EC2A: within 20% of true value from 60 keV to 3 MeV

Model 2401-PA: energy dependent

**Operating Voltage:** typically 550 Vdc for peanut tube detectors (as in Models 2401-ECA, 2401-EWA, and 2401-EC2A); 900 Vdc for pancake tube detector (as in the Model 2401-PA)

**Power:** one 9-volt battery; typical life is 250 hours at normal background radiation levels

**Response Time:** typically 11 seconds or less from 10% to 90% of the final reading

**Accuracy:** within 10% of true reading

**Meter:** 6.4 cm (2.5 in.) arc, 1 mA rugged analog meter

**Calibration Controls:** Located underneath the calibration cover on the front panel, these potentiometers allow adjustment of the  $\times 1$ ,  $\times 10$ , and  $\times 100$  ranges as well as the ALARM set point.

**Audio:** Speaker emits a click-per-radiation event. The sound level is typically 70 dB at 60.1 cm (2 ft) and can be turned off by placing the selector switch in the QUIET position. The audio speaker also emits a steady tone when the battery level drops, indicating the need for battery replacement. In addition, the speaker works in conjunction with the ALARM LED to indicate an alarm condition.

**Alarm:** The alarm point may be set from 0 to full-scale meter deflection. Detected radiation in excess of the set alarm point will trigger a red ALARM LED and a steady audible tone whether in NORMAL or QUIET operating mode.

**Size:** 4.6 x 8.4 x 13.5 cm (1.8 x 3.3 x 5.3 in.) (H x W x L)

**Weight:** 0.4 kg (0.9 lb), including battery

**Finish:** drawn-and-cast aluminum fabrication, with beige powder-coat paint and a recessed subsurface-printed membrane panel

## Section

## 4

## Identification of Controls and Functions

---

**Meter Face:** Meter faces vary within the series, though all come standard with a mR/hr scale and a BAT OK scale. In addition, most meter faces have a cpm scale. The actual radiation measurement is determined by multiplying the meter face reading by the multiple associated by the selected position of the range switch.

**Important!**

Units of exposure rate, such as mR/hr, apply to gamma radiation only. However, exposure rate readings on the Model 2401-EWA or 2401-PA may be affected by alpha and beta particles if they are not intentionally blocked.

**Range Switch:** This is a three-position switch marked  $\times 1$ ,  $\times 10$ , and  $\times 100$ . Moving the range switch to one of the range multiplier positions ( $\times 100$ ,  $\times 10$ ,  $\times 1$ ) provides the operator with an overall range dependent upon the series of instrument and detector used. Multiply the scale reading by the multiplier to determine the actual scale reading.

**Selector Switch:** Sliding the range switch from OFF to BAT CHECK provides the operator with a battery check of the instrument. A BAT OK scale on the meter face provides a visual means of checking the battery-charge status. Placing this switch in the NORMAL position puts the instrument into normal operating mode and energizes the unimorph speaker located on the left side of the instrument. The number of audible clicks is relative to the meter reading; the higher the reading, the more audible clicks. To reduce battery drain, the switch should be placed in the QUIET position when the audio function is not needed.

**Alarm Set Point Adjustment:** This is a recessed potentiometer located under the front-panel calibration cover used to adjust the alarm set point. The point is set by placing the instrument in a field of radiation where the meter reading comes to the desired point of alarm and then adjusting the potentiometer just until the alarm indicators are activated.

Alternatively, a Ludlum Model 500 Pulser (or equivalent) may be used to inject counts, at the detector anode, to the desired meter reading.

**Range Calibration Adjustments:** These are recessed potentiometers located under the front-panel calibration cover that allow for individual calibration of each range multiplier.

**Crosshairs:** The crosshairs above the meter on the black, front panel indicate the location of the center of the detector. The exception to this is in the case of the Model 2401-PA where the center of the detector is visible on the back side of the instrument. When surveying for radiation, position the instrument as close as possible to the area to be measured, with the detector centered.

**Section****5**

## Safety Considerations and Maintenance

---

### Environmental Conditions for Normal Use

Indoor or outdoor use

No maximum altitude with the exception of the Model 2401-EWA and 2401-PA where an altitude of 2438 m (8000 ft) above sea level should not be exceeded. The later two instruments must be sealed in an airtight container when transported by air in order to prevent damage to the detector.

Temperature range of -20 to 50°C (-4 to 122°F); may be certified for operation from -40 to 65 °C (-40 to 150 °F)

Maximum relative humidity of 95% (non-condensing) (Pollution Degree 3 (as defined by IEC 664) (Occurs when conductive pollution or dry nonconductive pollution becomes conductive due to condensation. This is typical of industrial or construction sites.)

### Warning Markings and Symbols

**Caution!**

The operator or responsible body is cautioned that the protection provided by the equipment may be impaired if the equipment is used in a manner not specified by Ludlum Measurements, Inc.

**The Model 2401 Alarming Series of Instruments are marked with the following symbols:**



**CAUTION** (per ISO 3864, No. B.3.1) – designates hazardous live voltage and risk of electric shock. During normal use, internal components are hazardous live. This instrument must be isolated or disconnected from the hazardous live voltage before accessing the internal components. This symbol appears on the front panel. **Note the following precautions:**

**Warning!**

The operator is strongly cautioned to take the following precautions to avoid contact with internal hazardous live parts that are accessible using a tool:

1. Turn the instrument power OFF and remove the battery.
2. Allow the instrument to sit for one minute before accessing internal components.



The “**crossed-out wheellie bin**” symbol notifies the consumer that the product is not to be mixed with unsorted municipal waste when discarding; each material must be separated. The symbol is placed on the front panel. See section 7, “Recycling,” for further information.



The “CE” mark is used to identify this instrument as being acceptable for use within the European Union.

## Mica Window Precaution

**Caution!**

Damage to the Mica window on the top of the Model 2401-EWA and on the back of the Model 2401-PA may result if careful instrument handling is not practiced. The window is very fragile and may be punctured quite easily.

## Cleaning and Maintenance Precautions

Instrument maintenance consists of keeping the instrument clean and periodically checking the battery, slide switches and calibration. The Model 2401 series of instruments (excluding detector window on Models 2401-EWA and 2401-PA) may be cleaned externally with a damp cloth, using only water as the wetting agent. Do not immerse the instrument in any liquid. Observe the following precautions when cleaning or performing maintenance on the instrument:

1. Turn the instrument OFF and remove the battery.
2. Allow the instrument to sit for one minute before cleaning the exterior or accessing any internal components for maintenance.



## Maintenance

### RECALIBRATION

Recalibration should be accomplished after maintenance or adjustments have been performed on the instrument. Recalibration is not normally required following instrument cleaning or battery replacement

**Note:**

Ludlum Measurements, Inc. recommends recalibration at intervals no greater than one year. Check appropriate local procedures and regulations to determine required recalibration intervals.

Ludlum Measurements offers a full-service repair and calibration department. We not only repair and calibrate our own instruments but most other manufacturers' instruments. Calibration procedures are available upon request for customers who choose to calibrate their own instruments.

### SLIDE SWITCHES

Use of the instrument in extremely dusty or dirty environments may cause the slide switches (instrument selector and range switch) to operate erratically. These switches may be restored to proper operation by applying low-pressure air to remove the accumulated dirt.

**Section****6**

## Radiation Basics

---

### Radiation and Life

*Adapted from Eric J. Hall's book, "Radiation and Life"*

Radiation is energy traveling through space. Sunshine is one of the most familiar forms of radiation. It delivers light, heat, and suntans. We control its effect on us with sunglasses, shade, air conditioners, hats, clothes, and sunscreen.

There would be no life on earth without lots of sunlight, but we have increasingly recognized that too much of it on our bodies is not a good thing. In fact, it may be dangerous, so we control our exposure to it.

Sunshine consists of radiation in a range of wavelengths from long-wave infrared to short-wavelength ultraviolet, which creates the hazard.

Beyond ultraviolet are higher energy kinds of radiation, which are used in medicine and that we all get in low doses from space, from the air, and from the earth. Collectively we can refer to these kinds of radiation as **ionizing radiation**. It can cause damage to matter, particularly living tissue. At high levels it is, therefore, dangerous, so it is necessary to control our exposure.

Background radiation is that which is naturally and inevitably present in our environment. Levels of this can vary greatly. People living in granite areas or on mineralized sands receive more terrestrial radiation than others, while people living or working at high altitudes receive more cosmic radiation. A lot of our natural exposure is due to radon, a gas which seeps from the earth's crust and is present in the air we breathe.

## The Unstable Atom

Radiation comes from atoms, the basic building blocks of matter.

Most atoms are stable; a carbon-12 atom, for example, remains a carbon-12 atom forever, and an oxygen-16 atom remains an oxygen-16 atom forever, but certain atoms eventually disintegrate into a totally new atom. These atoms are said to be “unstable” or radioactive. An unstable atom has excess internal energy, with the result that the nucleus can undergo a spontaneous change towards a more stable form. This is called radioactive decay.

When an atom of a radioisotope decays, it gives off some of its excess energy as radiation in the form of gamma rays or fast-moving, sub-atomic particles. One can describe the emissions as gamma, beta, and alpha radiation.

Apart from the normal measures of mass and volume, the amount of radioactive material is given in **curie (Ci)**, a measure that enables us to compare the typical radioactivity of some natural and other materials.

**Radioactivity of some natural and other materials**

1 adult human (2.7 X 10 <sup>-9</sup> Ci/kg)	1.89 X 10 <sup>-7</sup> Ci
1 kg (2.2 lb) of coffee	2.70 X 10 <sup>-8</sup> Ci
1 kg (2.2 lb) of super phosphate fertilizer	1.35 X 10 <sup>-7</sup> Ci
The air in a 100 m <sup>2</sup> (1076 ft <sup>2</sup> ) Australian home (radon)	8.12 X 10 <sup>-8</sup> Ci
The air in many 100 m <sup>2</sup> (1076 ft <sup>2</sup> ) European homes (radon)	8.12 X 10 <sup>-7</sup> Ci
1 household smoke detector (with americium)	8.12 X 10 <sup>-7</sup> Ci
Radioisotope for medical diagnosis	1.89 X 10 <sup>-3</sup> Ci
Radioisotope source for medical therapy	2702.7 Ci
1 kg (2.2 lb) of 50-year old vitrified high-level nuclear waste	270.27 Ci
1 luminous Exit sign (1970s)	27.027 Ci
1 kg (2.2 lb) of uranium	675.68 X 10 <sup>-6</sup> Ci
1 kg (2.2 lb) of uranium ore (Canadian, 15%)	675.68 X 10 <sup>-6</sup> Ci

1 kg (2.2 lb) of uranium ore (Australian, 0.3%)	13.51 X 10 <sup>-6</sup> Ci
1 kg (2.2 lb) of low-level radioactive waste	27.03 X 10 <sup>-6</sup> Ci
1 kg (2.2 lb) of coal ash	5.41 X 10 <sup>-8</sup> Ci
1 kg (2.2 lb) of granite	2.70 X 10 <sup>-8</sup> Ci

NB. Though the intrinsic radioactivity is the same, the radiation dose received by someone handling a kilogram of high grade uranium ore will be much greater than for the same exposure to a kilogram of separated uranium, since the ore contains a number of short-lived decay products (see section on Radioactive Decay).

## Radioactive Decay

Atoms in a radioactive substance decay in a random fashion but at a characteristic rate. The length of time this takes, the number of steps required, and the kinds of radiation released at each step are well known.

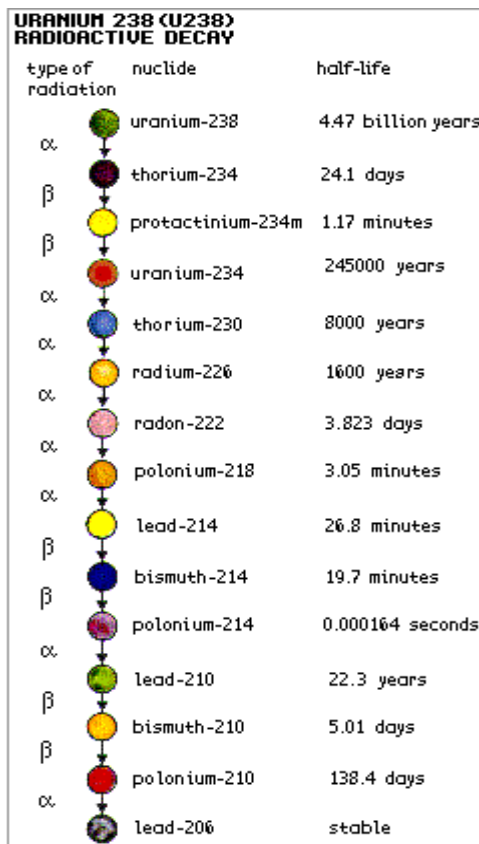

The half-life is the time taken for half of the atoms of a radioactive substance to decay. Half-lives can range from less than a millionth of a second to millions of years, depending upon the element concerned. After one half-life, the level of radioactivity of a substance is halved, after two half-lives, it is reduced to one quarter, after three half-lives, to one-eighth and so on.

All uranium atoms are mildly radioactive. The following figure for uranium-238 shows the series of different radioisotopes it becomes as it decays, the type of radiation given off at each step and the half-life of each step on the way to stable, non-radioactive lead-206. The shorter-lived each kind of radioisotope, the

more radiation it emits per unit mass. Much of the natural radioactivity in rocks and soil comes from this decay chain.

## Ionizing Radiation

Here we are concerned mainly with ionizing radiation from the atomic nucleus. It occurs in two forms – rays and particles – at the high frequency end of the energy spectrum.

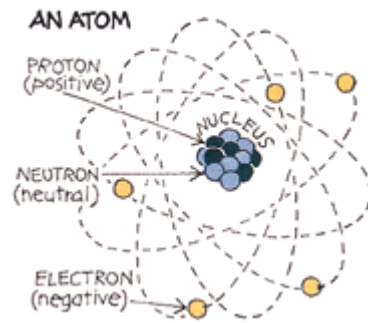

There are several types of ionizing radiation:

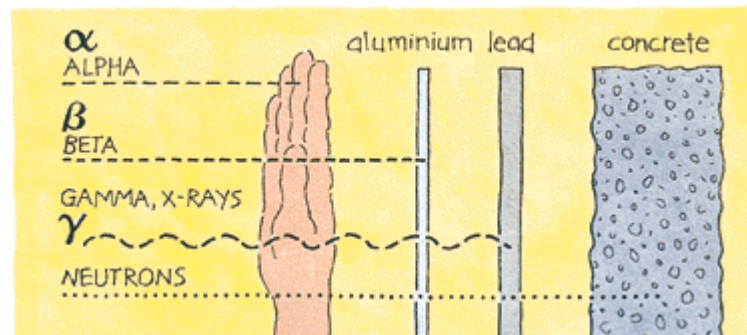

**X-rays and gamma rays**, like light, represent energy transmitted in a wave without the movement of material, just as heat and light from a fire or the sun travel through space. X-rays and gamma rays are virtually identical, except that X-rays are generally produced artificially rather than coming from the atomic nucleus. Unlike light, X-rays and gamma rays have great penetrating power and can pass through the human body. Thick barriers of concrete, lead, or water are used as protection from them.

**Alpha particles** consist of two protons and two neutrons, in the form of atomic nuclei. They thus have a positive electrical charge and are emitted from naturally occurring heavy elements such as uranium and radium, as well as from some man-made elements. Because of

their relatively large size, alpha particles collide readily with matter and lose their energy quickly. They, therefore, have little penetrating power and can be stopped by the first layer of skin or a sheet of paper.

However, if alpha sources are taken into the body, for example by breathing or swallowing radioactive dust, alpha particles can affect the body's cells. Inside the body, because they give up their energy over a relatively short distance, alpha particles can inflict more severe biological damage than other radiations.

**Beta particles** are fast-moving electrons ejected from the nuclei of atoms. These particles are much smaller than alpha particles and can penetrate up to 0.20 cm (5/64 of an inch) of water or human flesh. Beta particles are emitted from many radioactive elements. They can be stopped by a sheet of aluminum a few millimeters thick.

**Neutrons** are particles that are also very penetrating. On Earth they mostly come from the splitting, or fissioning, of certain atoms inside a nuclear reactor. Water and concrete are the most commonly used shields against neutron radiation from the core of the nuclear reactor.

**Note:**

It is important to understand that alpha, beta, gamma and X-radiation do not cause the body, or any object around the source, to become radioactive. However, most materials in their natural state (including body tissue) contain measurable amounts of radioactivity.

## Measuring Ionizing Radiation

### ***RAD and REM***

The human senses cannot detect radiation or discern whether a material is radioactive. However, a variety of instruments can detect and measure radiation reliably and accurately.

The amount of ionizing radiation, or 'dose', received by a person is measured in terms of the energy absorbed in the body tissue, and is expressed in **RAD**. One rad is 0.01 joules deposited per kilogram of mass.

Equal exposure to different types of radiation expressed as RAD, do not however, necessarily produce equal biological effects. One rad of alpha radiation, for example, will have a greater effect than one rad of beta radiation. When we talk about radiation effects, we, therefore, express the radiation as effective dose in a unit called the **REM** (Roentgen Equivalent Man).

Regardless of the type of radiation, one rem of radiation produces the same biological effect. (100 rem = 1 Sv)

Smaller quantities are expressed in mrem (one thousandth of a rem) or  $\mu$ rem (one millionth of a rem). We will use the most common unit, rem, here.

## What Are The Health Risks From Ionizing Radiation?

It has been known for many years that large doses of ionizing radiation, much larger than background levels, can cause a measurable increase in cancers and leukemias (cancer of the blood) after some years delay. It must also be assumed, because of experiments on plants and animals, that ionizing radiation can also cause genetic mutations that affect future generations, although there has been no evidence of radiation-induced mutation in humans. At very high levels, radiation can cause sickness and death within weeks of exposure. (See table on next page.)

But what are the chances of developing cancer from low doses of radiation? The prevailing assumption is that any dose of radiation, no matter how small, involves a possibility of risk to human health. However there is no scientific evidence of risk at doses below approximately 5 rem in a short period of time or about 10 rem over a period of one year.

Higher accumulated doses of radiation might produce a cancer that would only be observed several years (up to 20) after the radiation exposure. This delay makes it impossible to say with any certainty which of many possible agents were the cause of a particular cancer. In western countries, about a quarter of people die from cancers, with smoking, dietary factors, genetic factors and strong sunlight being among the main causes. Radiation is a weak carcinogen, but undue exposure could certainly increase health risks.

On the other hand, large doses of radiation directed specifically at a tumor are used in radiation therapy to kill cancerous cells, and thereby often save lives (usually in conjunction with chemotherapy or surgery). Much larger doses are used to kill harmful bacteria in food, and to sterilize bandages and other medical equipment. Radiation has become a valuable tool in our modern world.

## How Much Ionizing Radiation is Dangerous?

### ***Radiation levels and their effects***

The following table gives an indication of the likely effects of a range of whole body radiation doses and dose rates to individuals:

**1,000 rem** as a short-term and whole-body dose would cause immediate illness, such as nausea and decreased white blood cell count, and subsequent death within a few weeks.

Between 200 and 1000 rem in a short-term dose would cause severe radiation sickness with increasing likelihood that this would be fatal.

**100 rem** in a short term dose is about the threshold for causing immediate radiation sickness in a person of average physical attributes, but would be unlikely to cause death. Above 100 rem, severity of illness increases with dose.

If doses greater than 100 rem occur over a long period they are less likely to have early health effects but they create a definite risk that cancer will develop many years later.

Above about **10 rem**, the probability of cancer (rather than the severity of illness) increases with dose. The estimated risk of fatal cancer is 5 of every 100 persons exposed to a dose of 100rem (ie. if the normal incidence of fatal cancer were 25%, this dose would increase it to 30%).

**5 rem** is, conservatively, the lowest dose at which there is any evidence of cancer being caused in adults. It is also the highest dose which is allowed by regulation in any one year of occupational exposure. Dose rates greater than 5 rem/yr arise from natural background levels in several parts of the world but do not cause any discernible harm to local populations.



**2 rem/yr** averaged over 5 years is the limit for radiological personnel such as employees in the nuclear industry, uranium or mineral sands miners, and hospital workers (who are all closely monitored).

**1 rem/yr** is the maximum actual dose rate received by any Australian uranium miner.

**300-500 mrem/yr** is the typical dose rate (above background) received by uranium miners in Australia and Canada.

**300 mrem/yr** (approx) is the typical background radiation from natural sources in North America, including an average of almost 200 mrem/yr from radon in air.

**200 mrem/yr** (approximately) is the typical background radiation from natural sources, including an average of 70 mrem/yr from radon in air. This is close to the minimum dose received by all humans anywhere on Earth.

**30-60 mrem/yr** is a typical range of dose rates from artificial sources of radiation, mostly medical.

**5 mrem/yr**, a very small fraction of natural background radiation, is the design target for maximum radiation at the perimeter fence of a nuclear electricity generating station. In practice, the actual dose is less.

### ***What is the risk estimate?***

According to the Biological Effects of Ionizing Radiation committee V (BEIR V), the risk of cancer death is 0.08% per rem for doses received rapidly (acute) and might be two to four times (0.04% per rem) less than that for doses received over a long period of time (chronic). These risk estimates are an average for all ages, males and females, and all forms of cancer. There is a great deal of uncertainty associated with the estimate.

Risk from radiation exposure has been estimated by other scientific groups. The other estimates are not the exact same as the BEIR V estimates, due to differing methods of risk and assumptions used in the calculations, but all are close.

### ***Risk comparison***

The real question is: how much will radiation exposure increase my chances of cancer death over my lifetime.

To answer this, we need to make a few general statements of understanding. One is that in the US the current death rate from cancer is approximately 20 percent, so out of any group of 10,000 United States citizens, about 2000 of them will die of cancer. Second, that contracting cancer is a random process,

where given a set population, we can estimate that about 20 percent will die from cancer, but we cannot say *which* individuals will die. Finally, that a conservative estimate of risk from low doses of radiation is thought to be one in which the risk is linear with dose. That is, that the risk increases with a subsequent increase in dose. Most scientists believe that this is a conservative model of the risk.

So, now the risk estimates: If you were to take a large population, such as 10,000 people and expose them to one rem (to their whole body), you would expect approximately eight additional deaths (0.08% X 10,000 X 1 rem). So, instead of the 2,000 people expected to die from cancer naturally, you would now have 2,008. This small increase in the expected number of deaths would not be seen in this group, due to natural fluctuations in the rate of cancer.

What needs to be remembered is that it is not known that 8 people will die, but that there is a risk of 8 additional deaths in a group of 10,000 people if they would all receive 1rem instantaneously.

If they would receive the 1 rem over a long period of time, such as a year, the risk would be less than half this (<4 expected fatal cancers).

Risks can be looked at in many ways. Here are a few ways to help visualize risk:

One way often used is to look at the number of "days lost" out of a population due to early death from separate causes, then dividing those days lost between the population to get an "Average Life expectancy lost" due to those causes. The following is a table of life expectancy lost for several causes:

<b>Health Risk</b>	<b>Est. life expectancy lost</b>
Smoking 20 cigarettes a day	6 years
Overweight (15%)	2 years
Alcohol (US Avg.)	1 year
All Accidents	207 days
All Natural Hazards	7 days
Occupational dose (300 mrem/yr)	15 days
Occupational dose (1 rem/yr)	51 days

You can also use the same approach to looking at risks on the job:

<b>Industry Type</b>	<b>Est. life expectancy lost</b>
All Industries	60 days
Agriculture	320 days
Construction	227 days
Mining and quarrying	167 days
Manufacturing	40 days
Occupational dose (300 mrem/yr)	15 days
Occupational dose (1 rem/yr)	51 days

These are estimates taken from the NRC Draft guide DG-8012 and were adapted from B.L. Cohen and I.S. Lee, "Catalogue of Risks Extended and Updates", *Health Physics*, Vol. 61, September 1991.

Another way of looking at risk, is to look at the Relative Risk of 1 in a million chances of dying of activities common to our society:

Smoking 1.4 cigarettes (lung cancer)
Eating 40 tablespoons of peanut butter
Spending 2 days in New York City (air pollution)
Driving 40 miles in a car (accident)
Flying 2500 miles in a jet (accident)
Canoeing for 6 minutes
Receiving 10 mrem of radiation (cancer)

Adapted from DOE Radiation Worker Training, based on work by B.L. Cohen, Sc.D.

## Background Radiation

Naturally occurring background radiation is the main source of exposure for most people. Levels typically range from about 150-350 mrem per year but can be more than 5rem/yr. The highest known level of background radiation affecting a substantial population is in Kerala and Madras States in India where some 140,000 people receive doses that average over 1.5 rem/year from gamma radiation, in addition to a similar dose from radon. Comparable levels occur in Brazil and Sudan, with average exposures up to about 4 rem/yr to many people.

Several places are known in Iran, India, and Europe where natural background radiation gives an annual dose of more than 5 rem and up to 26 rem (at Ramsar in Iran). Lifetime doses from natural radiation range

up to a couple thousand rem. However, there is no evidence of increased cancers or other health problems arising from these high natural levels.

## Man-made Radiation

Ionizing radiation is also generated in a range of medical, commercial, and industrial activities. The most familiar and, in national terms, the largest of these sources of exposure is medical X-rays.

Natural radiation contributes about 88% of the annual dose to the population and medical procedures contribute most of the remaining 12%. Natural and artificial radiations are not different in kind or effect.

## Protection from Radiation

Radiation is very easily detected. There is a range of simple, sensitive instruments capable of detecting minute amounts of radiation from natural and man-made sources. There are three ways in which people are protected from identified radiation sources:

**Limiting time:** For people who are exposed to radiation in addition to natural background radiation through their work, the dose is reduced and the risk of illness essentially eliminated by limiting exposure time. Proper job planning is essential in achieving lowest exposure time. Always plan for the unexpected to eliminate delays in the exposure area.

**Distance:** In the same way that heat from a fire is less the further away you are, so the intensity of radiation decreases with distance from its source. Distance is the easiest, fastest, and most practical way to limit exposure.

**Shielding:** Barriers of lead, concrete, or water give good protection from penetrating radiation such as gamma rays. Highly radioactive materials are, therefore, often stored or handled under water, or by remote control in rooms constructed of thick concrete or lined with lead.

## Standards and Regulation

Much of the evidence that has led to today's standards derives from the atomic bomb survivors in 1945, which were exposed to high doses incurred in a very short time. In setting occupational risk estimates, some allowance has been made for the body's ability to repair damage from small exposures, but for low-level radiation exposure, the degree of protection may be unduly conservative.

Most countries have their own systems of radiological protection, which are often based on the recommendations of the International Commission on Radiological Protection (ICRP). The “authority” of the ICRP comes from the scientific standing of its members and the merit of its recommendations.

## Who is in charge?

Ultimately, you are. All of the sources of radiation, other than natural, are regulated by laws passed by Congress. Like any other law, you have your right to voice your views and opinions about it. The regulations that control the use of radioactivity in our country are based upon recommendations of science organizations like the International Commission on Radiological Protection (ICRP), the National Council on Radiation Protection (NCRP), the International Atomic Energy Agency (IAEA), the United Nations (UN), and the Health Physics Society (HPS). Governing bodies like the Environmental Protection Agency (EPA), the Nuclear Regulatory Commission (NRC), the Department of Energy (DOE), and the Food and Drug Administration (FDA) review these recommendations and propose the regulations that industry and government must follow. These are then passed by Congress, if found to be acceptable, and published in the Code of Federal Regulations (CFRs).

**Note:**

The CFR limits the general public to radiation exposure of 100 mrem/year, with no more than 2 mrem of exposure in any one hour (ref. 10 CFR 20.1301).

**Section**  
**7**

**Recycling**

Ludlum Measurements, Inc. supports the recycling of the electronics products it produces for the purpose of protecting the environment and to comply with all regional, national, and international agencies that promote economically and environmentally sustainable recycling systems. To this end, Ludlum Measurements, Inc. strives to supply the consumer of its goods with information regarding reuse and recycling of the many different types of materials used in its products. With many different agencies – public and private – involved in this pursuit it becomes evident that a myriad of methods can be used in the process of recycling. Therefore, Ludlum Measurements, Inc. does not suggest one particular method over another, but simply desires to inform its consumers of the range of recyclable materials present in its products, so that the user will have flexibility in following all local and federal laws.

The following types of recyclable materials are present in Ludlum Measurements, Inc. electronics products, and should be recycled separately. The list is not all-inclusive, nor does it suggest that all materials are present in each piece of equipment:

- |                |          |                              |
|----------------|----------|------------------------------|
| Batteries      | Glass    | Aluminum and Stainless Steel |
| Circuit Boards | Plastics | Liquid Crystal Display (LCD) |

Ludlum Measurements, Inc. products, which have been placed on the market after August 13, 2005, have been labeled with a symbol recognized internationally as the “crossed-out wheelee bin. This notifies the consumer that the product is not to be mixed with unsorted municipal waste when discarding; each material must be separated. The symbol is placed on the instrument front panel and appears as such:



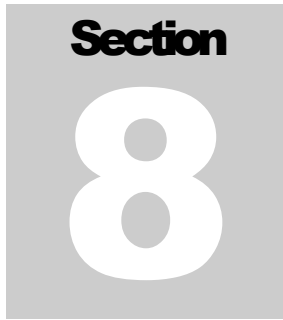

## Parts List

---

	<u>Reference</u>	<u>Description</u>	<u>Part Number</u>
<b>Models 2401-ECA, 2401-EWA and 2401- EC2A Survey Meters</b>	UNIT	Completely Assembled Survey Meter:	
		Model 2401-ECA	48-2996
		Model 2401-EWA	48-2997
		Model 2401-EC2A	48-2995
<b>Main Board, Drawing 397 x 87</b>	BOARD	Completely Assembled Main Circuit Board	5397-085
CAPACITORS	C001	68 $\mu$ F, 6.3V	04-5654
	C021	470PF, 100V	04-5668
	C031-C039	470PF, 1KV	04-5693
	C041	470PF, 1KV	04-5693
	C101	10 $\mu$ F, 20V	04-5655
	C102	0.0015 $\mu$ F, 100V	04-5680
	C111	0.1 $\mu$ F, 50V	04-5663
	C131-C132	47PF, 100V	04-5660
	C211	10 $\mu$ F, 20V	04-5655
	C231	0.022 $\mu$ F, 50V	04-5667
	C232	27PF, 100V	04-5658
	C233	100PF, 100V	04-5661
	C0310	470PF, 1KV	04-5693
	C0311	10 $\mu$ F, 20V	04-5655
	C0312	27PF, 100V	04-5658
	TRANSISTORS	Q021	2N7002L
Q031		MTD2N50	05-5855
Q131		MMBT3904T	05-5841
Q221		2N7002L	05-5840

	<u>Reference</u>	<u>Description</u>	<u>Part Number</u>
INTEGRATED CIRCUITS	U021	ICM7555CBA	06-6300
	U101	MAX638AESA	06-6389
	U131	MAX641BCSA	06-6388
	U211	CA3096M	06-6288
	U212	TLC27M7ID	06-6292
	U221	CD74HC4066M	06-6323
	U231	CD74HC4538M	06-6297
	LED	DS121	ALARM, HLMP4700
DIODES	CR001	CXSH-4	07-6358
	CR011	CXSH-4	07-6358
	CR031-CR034	CMPD2004S	07-6402
	CR041	CMPD2004S	07-6402
THERMISTOR	R214	250	07-6366
SWITCHES	S111	OFF-ON-BAT-QUIET	08-6764
	S112	RANGE	08-6763
POTENTIOMETERS	R101	1M, ×1 ADJ	09-6911
	R105	1M, ×10 ADJ	09-6911
	R107	100K, ×100 ADJ	09-6930
	R201	100K, ALARM ADJ.	09-6930
RESISTORS	R001	475K, 125mW, 1%	12-7859
	R002	165K, 125mW, 1%	12-7877
	R021	475K, 125mW, 1%	12-7859
	R022	1.00K, 125mW, 1%	12-7832
	R031	1.00M, 125mW, 1%	12-7844
	R032	3.32M, 125mW, 1%	12-7967
	R033	1.00M, 125mW, 1%	12-7844
	R034	392K, 125mW, 1%	12-7841
	R035-R036	1.00M, 125mW, 1%	12-7844
	R102	10.0K, 125mW, 1%	12-7839
	R103	100K, 125mW, 1%	12-7834
	R111	100K, 125mW, 1%	12-7834
	R104	10.0K, 125mW, 1%	12-7839
	R106	1.00K, 125mW, 1%	12-7832
	R111-R112	100K, 125mW, 1%	12-7834
	R113	665K, 125mW, 1%	12-7977
	R121	1G	12-7686



	<u>Reference</u>	<u>Description</u>	<u>Part Number</u>
	R131-R132	100K, 125mW, 1%	12-7834
	R133	10.0K, 125mW, 1%	12-7839
	R202	100K, 125mW, 1%	12-7834
	R211	1.00K, 125mW, 1%	12-7832
	R212	33.2K, 250mW, 1%	12-7842
	R213	301, 125mW, 1%	12-7863
	R215	475K, 125mW, 1%	12-7859
	R221-R222	1.00M, 125mW, 1%	12-7844
	R223	33.2K, 250mW, 1%	12-7842
	R224	1.00M, 125mW, 1%	12-7844
	R231	100K, 125mW, 1%	12-7834
	R232	1.00M, 125mW, 1%	12-7844
	R233	100K, 125mW, 1%	12-7834
INDUCTORS	L001	150μHY	21-9677
	L021	220μHY	21-9678
	L131	470μHY	21-9699
MISCELLANEOUS	P1	CONNECTOR-640456-2 MTA100×2, METER	13-8073
	DS11	UNIMORPH	21-9782
	B121	BATTERY HOLDER	22-9404
MISCELLANEOUS ASSEMBLY COMPONENTS	*	GM TUBE: Model 2401-ECA: LND71210	01-5295
		Model 2401-EWA: LND712	01-5032
		Model 2401-EC2A: LND71412	01-5306
	*	FP & METER ASSY.:	
		Model 2401-EWA	4397-068
		Model 2401-ECA	4397-069
		Model 2401-EC2A	4397-070
	*	Battery, Alkaline, 9V	21-9282
	1 ea.	MODEL 2401 COVER GASKET	7397-183
	*	CAN ×10:	
		Model 2401-EWA	7397-053
		Model 2401-ECA/EC2A	7397-052
	1 ea.	Unimorph Gasket	7397-063
	2 ea.	Switch Slot Cover	7397-060
	1 ea.	MODEL 2401 CAL COVER	9397-035

	<u>Reference</u>	<u>Description</u>	<u>Part Number</u>
<b>Model 2401-PA Survey Meter</b>	UNIT	Completely Assembled Model 2401-PA Survey Meter	48-3400
<b>Main Board, Drawing 397 × 190</b>	BOARD	Assembled Model 2401-PA Main Circuit Board	5397-190
CAPACITORS	C001	68μF, 6.3V	04-5654
	C021	470PF, 100V	04-5668
	C031-C039	470PF, 1KV	04-5693
	C041	470PF, 1KV	04-5693
	C101	10μF, 20V	04-5655
	C102	0.0015μF, 100V	04-5680
	C111	0.1μF, 50V	04-5663
	C131	47PF, 100V	04-5660
	C132	47PF, 100V	04-5660
	C211	10μF, 20V	04-5655
	C231	0.022μF, 50V	04-5667
	C232	27PF, 100V	04-5658
	C233	100PF, 100V	04-5661
	C0310	470PF, 100V	04-5693
	C0311	10μF, 20V	04-5655
	C0312	27PF, 100V	04-5658
TRANSISTORS	Q021	2N7002L	05-5840
	Q031	MTD2N50	05-5855
	Q131	MMBT3904T	05-5841
	Q221	2N7002L	05-5840
INTEGRATED CIRCUITS	U021	ICM7555CBA	06-6300
	U101	MAX638AESA	06-6389
	U131	MAX641BCSA	06-6388
	U211	CA9036M	06-6288
	U212	TLC27M7ID	06-6292
	U221	CD74HC4066M	06-6323
	U231	CD74HC4538M	06-6297
DIODES	DS121	LED1, HLMP4700	07-6356
	CR001	CXSH-4	07-6358
	CR011	CXSH-4	07-6358
	CR31- CR34	CMPD2004S	07-6402
	CR41	CMPD2004S	07-6402
	CR101	CXSH-4 EB33	07-6358

	<u>Reference</u>	<u>Description</u>	<u>Part Number</u>
THERMISTOR	R216	250	07-6366
SWITCHES	S111	OFF-ON-BAT-QUIET	08-6764
	S112	RANGE	08-6763
POTENTIOMETERS	R101	1.00M, ×1 ADJ	09-6911
	R105	1.00M, ×10 ADJ	09-6911
	R107	100K, ×100 ADJ	09-6930
	R201	100K, ALARM ADJ	09-6930
RESISTORS	R001	475K, 125mW, 1%	12-7859
	R002	165K, 125mW, 1%	12-7877
	R021	475K, 125mW, 1%	12-7859
	R022	1.00K, 125mW, 1%	12-7832
	R031	1.00M, 125mW, 1%	12-7844
	R032	3.32M, 125mW, 1%	12-7967
	R033	1.00M, 125mW, 1%	12-7844
	R034	392K, 125mW, 1%	12-7841
	R035-R036	1.00M, 125mW, 1%	12-7844
	R102	10.0K, 125mW, 1%	12-7839
	R103	100K, 125mW, 1%	12-7834
	R104	10.0K, 125mW, 1%	12-7839
	R106	1.00K, 125mW, 1%	12-7832
	R111-R112	100K, 125mW, 1%	12-7834
	R113	665K, 250mW, 1%	12-7977
	R121	1G	12-7686
	R131-R132	100K, 125mW, 1%	12-7834
	R133	10.0K, 125mW, 1%	12-7839
	R202	100K, 125mW, 1%	12-7834
	R211	1.00K, 125mW, 1%	12-7832
	R212	33.2K, 125mW, 1%	12-7842
	R213	301, 125mW, 1%	12-7863
	R215	75K, 125mW, 1%	12-7859
	R221- R222	1.00M 125mW, 1%	12-7844
	R223	33.2K, 125mW, 1%	12-7842
	R224	1.00M, 125mW, 1%	12-7844
	R231	100K, 125mW, 1%	12-7834
	R232	1.00M, 125mW, 1%	12-7844
	R233	100K, 125mW, 1%	12-7834

	<u>Reference</u>	<u>Description</u>	<u>Part Number</u>
INDUCTORS	L001	150μHY	21-9677
	L021	220μHY	21-9678
	L131	470μHY	21-9699
MISCELLANEOUS	P1	CONNECTOR 640456-2, MTA100×2, METER	13-8073
	B122	BATTERY-HLDR #1294 9V PCB	22-9404
	DS011	UNIMORPH-PKM22EPP-4001	21-9782
MISCELLANEOUS ASSEMBLY COMPONENTS	*	GM TUBE - LND7311	01-5008
	*	Tube Clip	01-5237
	*	MODEL 2401-PA FP & METER ASSY.	4397-188
	*	Battery, alkaline, 9V	21-9282
	1ea.	Unimorph Gasket	7397-063
	2ea.	Switch Slot Cover	7397-060
	*	MODEL 2401-P CAN	7397-038
	*	MODEL 2401-P PANCAKE SCREEN	7397-042
	*	MODEL 2401-P TUBE HOLDER GASKET	7397-065
	*	TUBE HOLDER BOTTOM BRACKET	7397-083
	*	TUBE HOLDER TOP BRACKET	7397-084
	*	MODEL 2401 CAL COVER	9397-035

A gray square graphic containing the word "Section" in a bold, black, sans-serif font at the top, and a large, white, sans-serif number "9" in the center.

## Drawings

---

Model 2401-ECA Front View, Drawing 397 × 100

Model 2401-EWA Front View, Drawing 397 × 101

Model 2401-EC2A Front View, Drawing 397 × 99

Model 2401-PA Front View, Drawing 397 × 188

Main Circuit Board Schematic, Drawing 397 × 87

Main Circuit Board Component Layout, Drawing 397 × 88 (2 sheets)

Main Circuit Board Schematic, Drawing 397 × 190

Main Circuit Board Component Layout, Drawing 397 × 191

REV #	ALTERATIONS	DATE	BY
1	VALID	4-22-02	JGW
2	ADDED CE MARK	9-15-05	CMC
3	ADDED SYMBOLS	04/25/06	PW

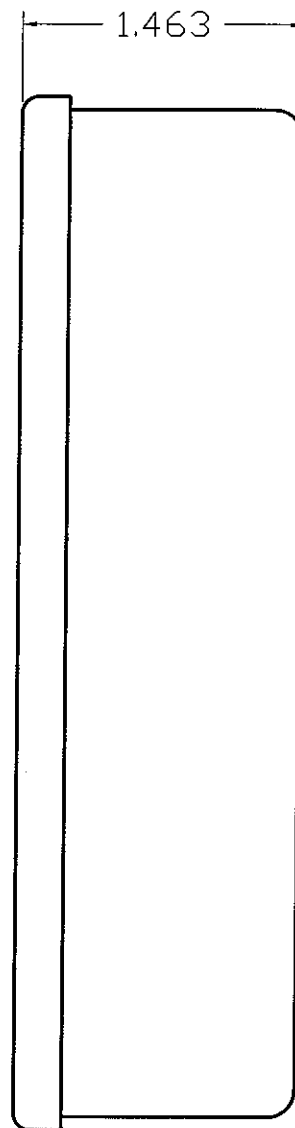
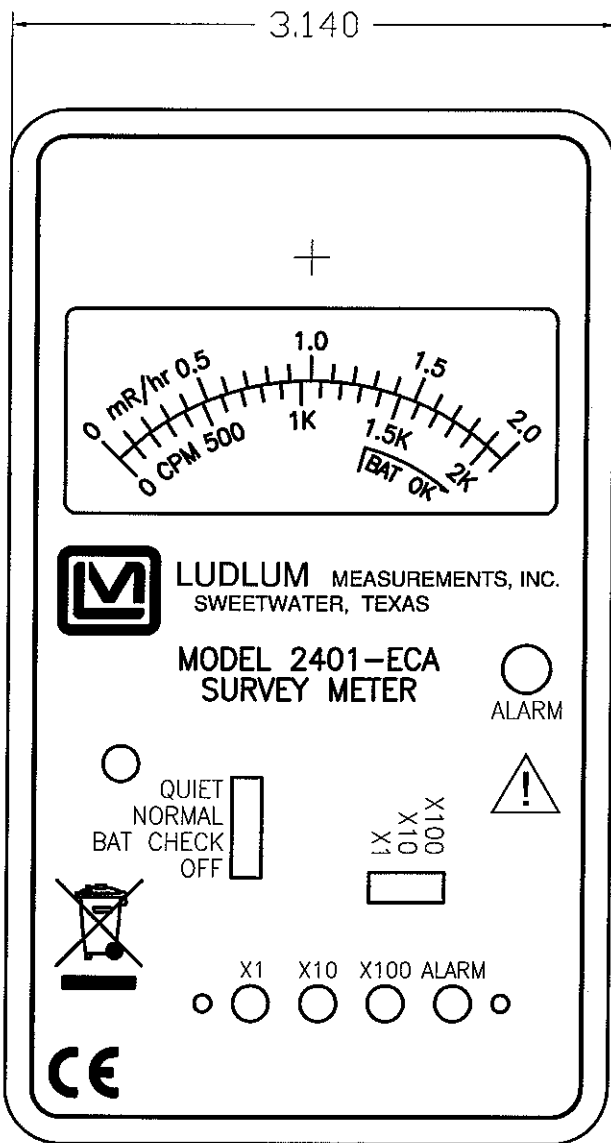

DWN PW	DATE 04/25/06	CHECKED	APPROVED JWS 4-25-06
TITLE: M 2401-ECA			
 <b>LUDLUM MEASUREMENTS, INC.</b> 501 DAK STREET SWEETWATER, TEXAS 79556		SERIES 397	SHEET 100

REV #	ALTERATIONS	DATE	BY
1	VALID	4-22-02	JGW
2	ADDED CE MARK	9-15-05	CMC
3	ADDED SYMBOLS	04/25/06	PW
4	SCALED 'DISCARD' SYMBOL DOWN BY 1/2	4/13/11	CMC

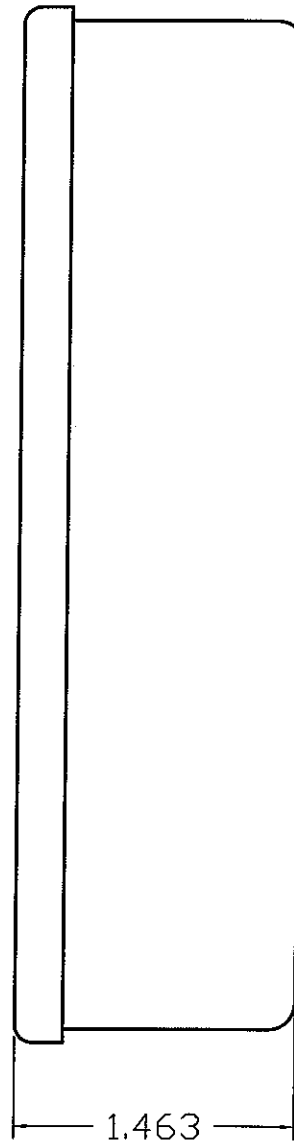
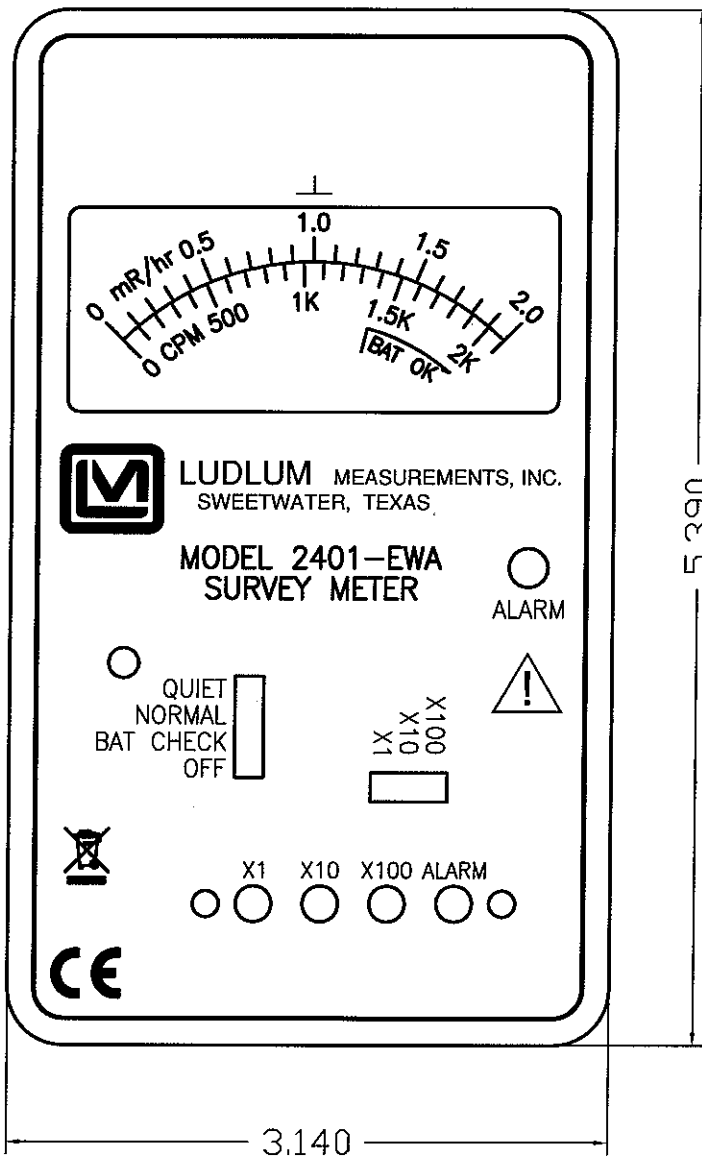
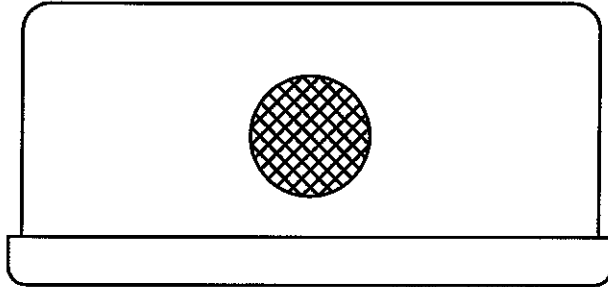

DWN CMC	DATE 4-13-11	CHECKED	APPROVED <i>RSS 13 April 11</i>
TITLE: M 2401-EWA			
LUDLUM MEASUREMENTS, INC. 501 DAK STREET SWEETWATER, TEXAS 75556		SERIES 397	SHEET 101

REV #	ALTERATIONS	DATE	BY
1	VALID	11-10-97	JGW
2	ADDED SYMBOLS	04/25/06	PW

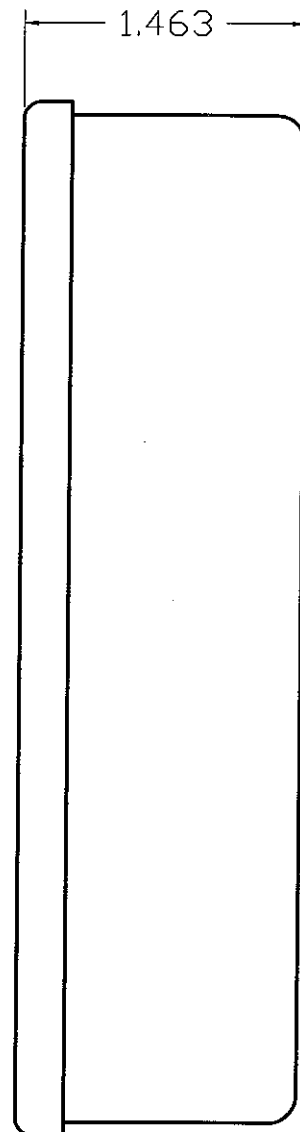
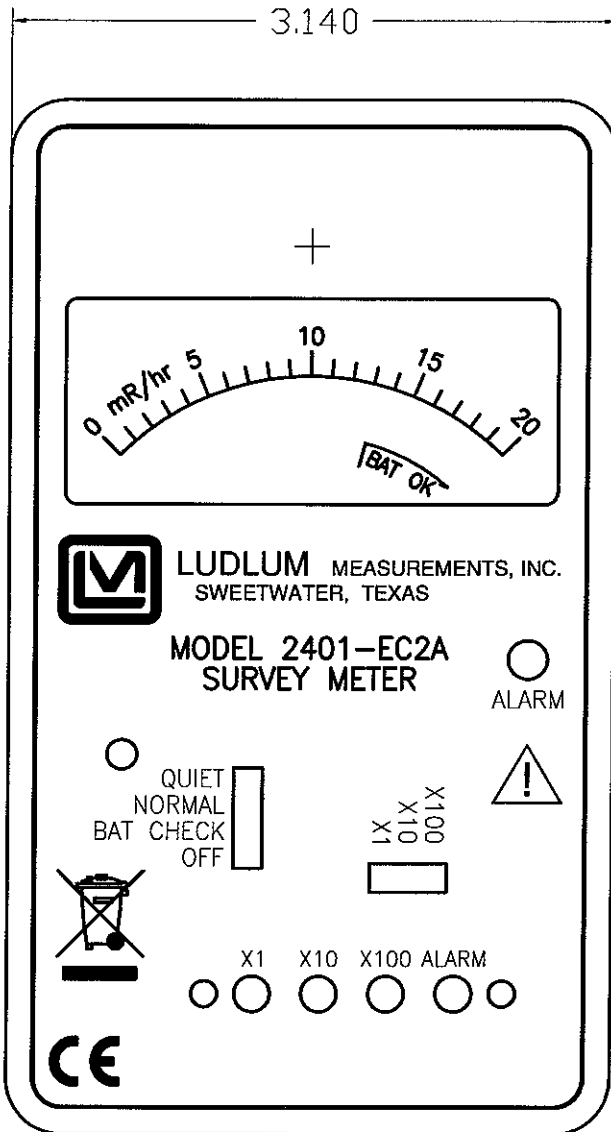

DWN	DATE	CHECKED	APPROVED
PW	04/25/06		JWS 4-25-06
TITLE: M 2401-EC2A			
LUDLUM MEASUREMENTS, INC. 501 OAK STREET SWEETWATER, TEXAS 79556		SERIES	SHEET
		397	99



REV#	ALTERATIONS	DATE	BY
1	VALID	04/25/06	PW
2	SCALED "DISCARD" SYMBOL DOWN BY 1/2	4-13-11	CMC

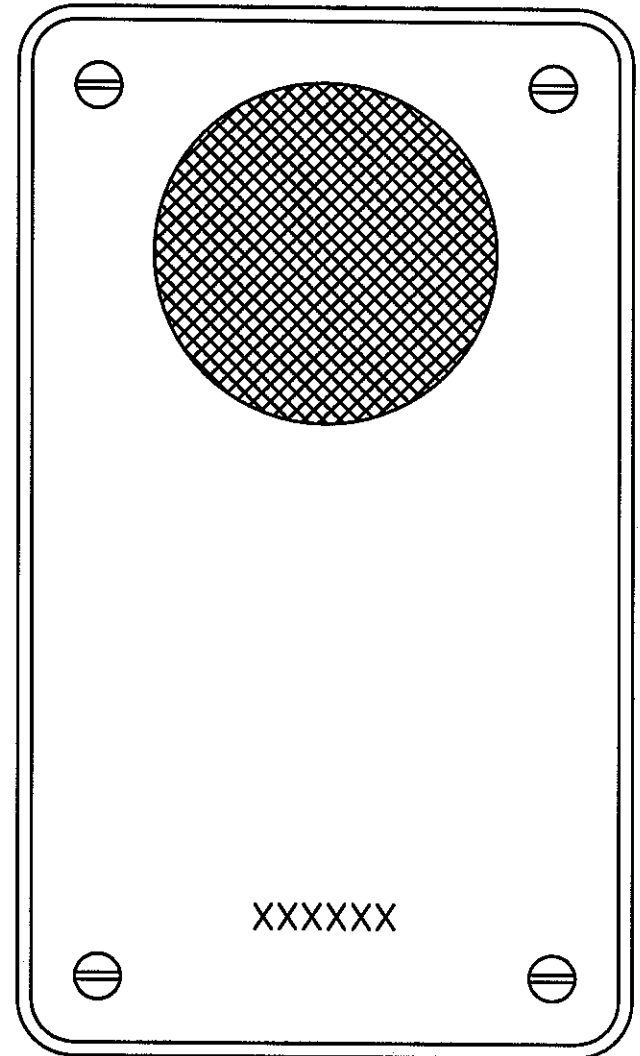
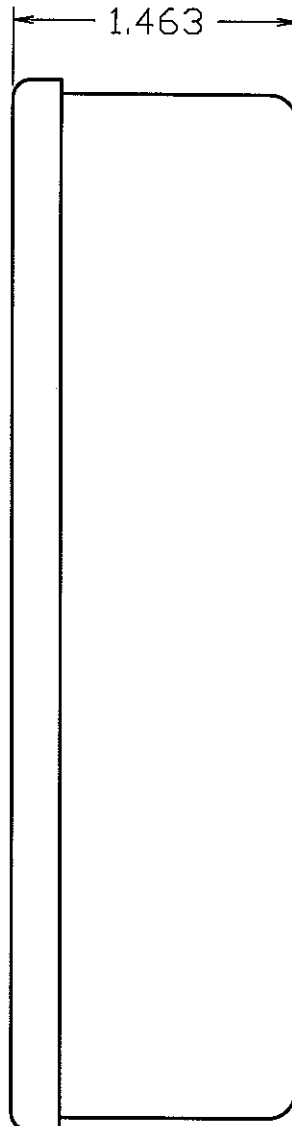
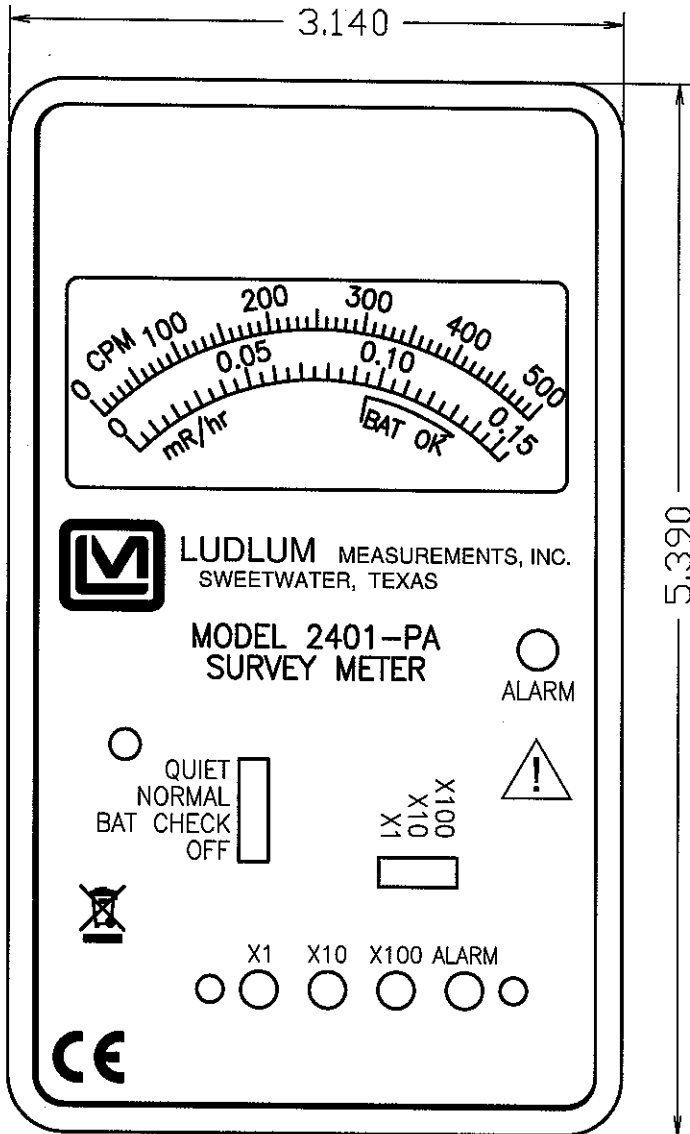

DWN CMC	DATE 4-13-11	CHECKED	APPROVED <i>RSB 10/11</i>
TITLE: M 2401-PA			
	LUDLUM MEASUREMENTS, INC. 301 OAK STREET SWEETWATER, TEXAS 79556	SERIES 397	SHEET 188

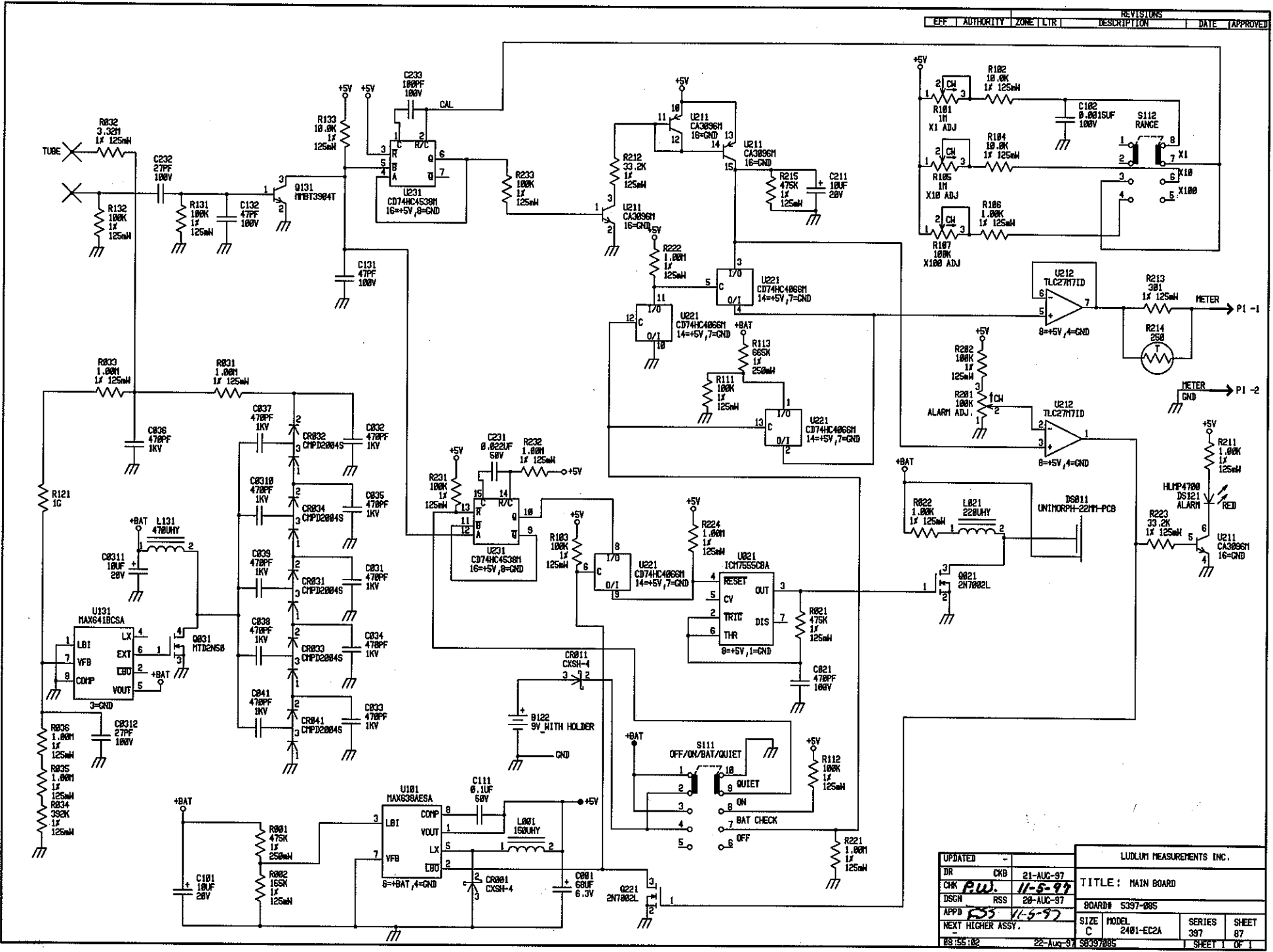

UPDATED			LUDLUM MEASUREMENTS INC.			
DR	CKB	21-AUG-97	TITLE: MAIN BOARD			
CHK	<i>P.W.</i>	<i>11-5-97</i>	BOARD# 5397-005			
DSGN	RSS	20-AUG-97	SIZE	MODEL	SERIES	SHEET
APPD	<i>BS</i>	<i>11-5-97</i>	C	2401-EC2A	397	87
NEXT HIGHER ASSY.			SHEET 87			
BB 55102			22-AUG-97 58397005			



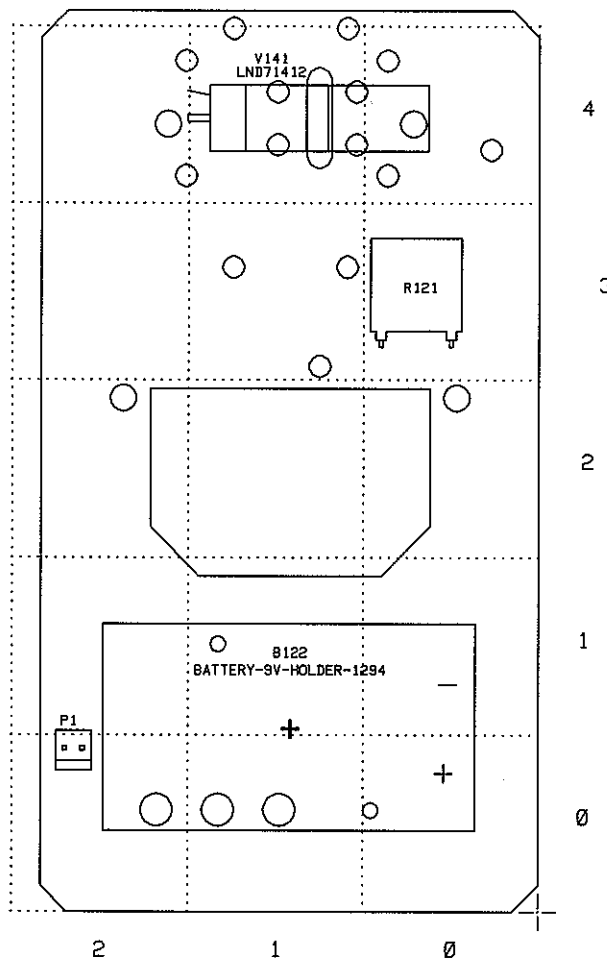

LUDLUM MEASUREMENTS INC. SWEETWATER, TX.			
DR	CKB	22-AUG-97	TITLE: MAIN BOARD
CHK	PW	11-5-97	BOARD# 5397-085
DSCN	RSS	20-AUG-96	MODEL 2401E2A   SERIES 397   SHEET 08
APP	RSS	11-5-97	COMP ARTHORK <input type="checkbox"/>   SLDR ARTHORK <input type="checkbox"/>
		COMP OUTLINE <input type="checkbox"/>	SLDR OUTLINE <input checked="" type="checkbox"/>
		COMP PASTE <input type="checkbox"/>	SLDR MASK <input type="checkbox"/>

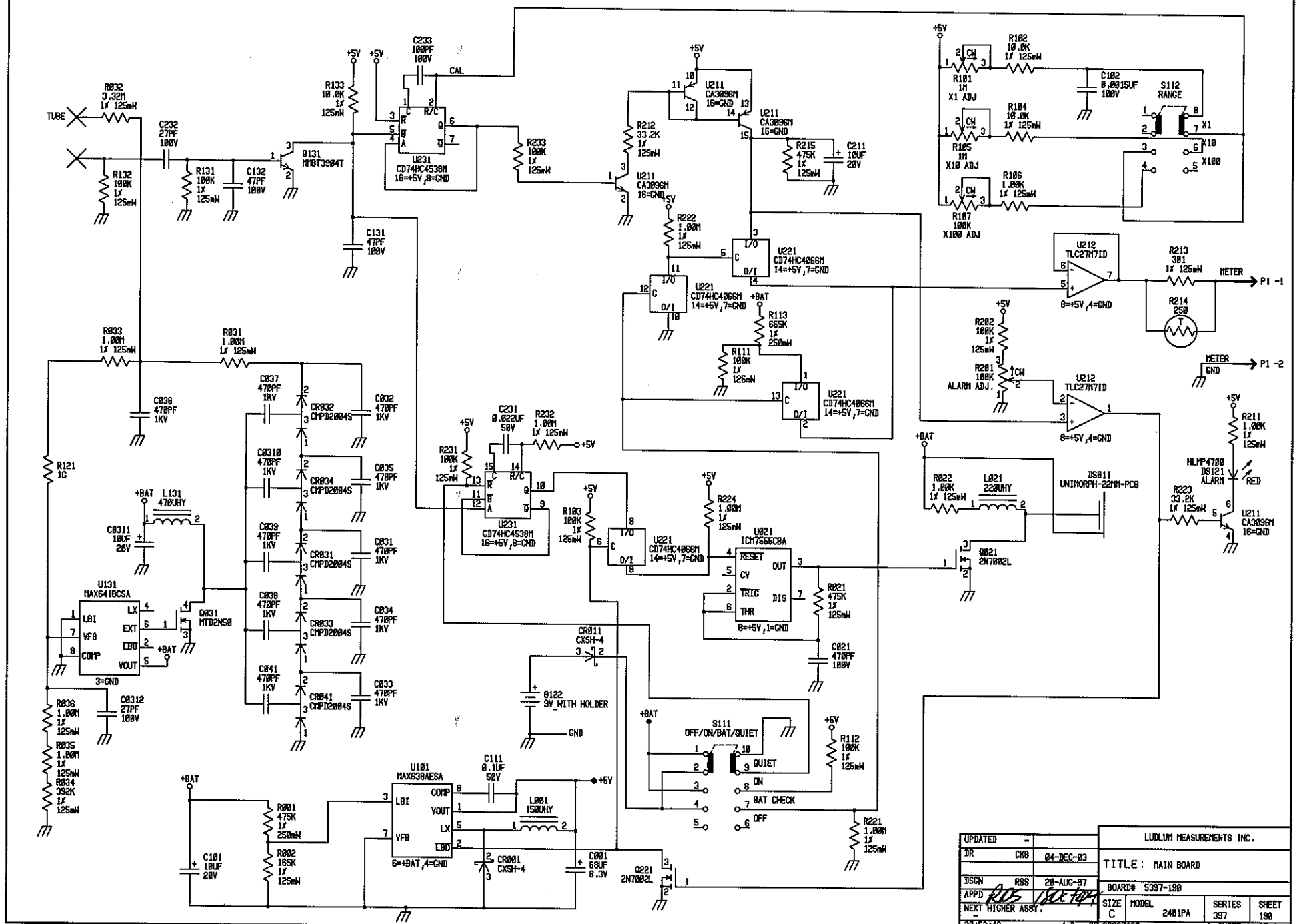

UPDATED	-	LUDLUM MEASUREMENTS INC.		
DR	CHB	04-DEC-83	TITLE: MAIN BOARD	
DSGN	RSS	28-AUG-87	BOARD#	5397-198
APPD	<i>RSS</i>	<i>10/1/87</i>	SIZE	MODEL
NEXT HIGHER ASSY.			C	2481PA
28:53:46		4-Dec-83	SERIES	397
			SB397198	SHEET 198
				OF 1

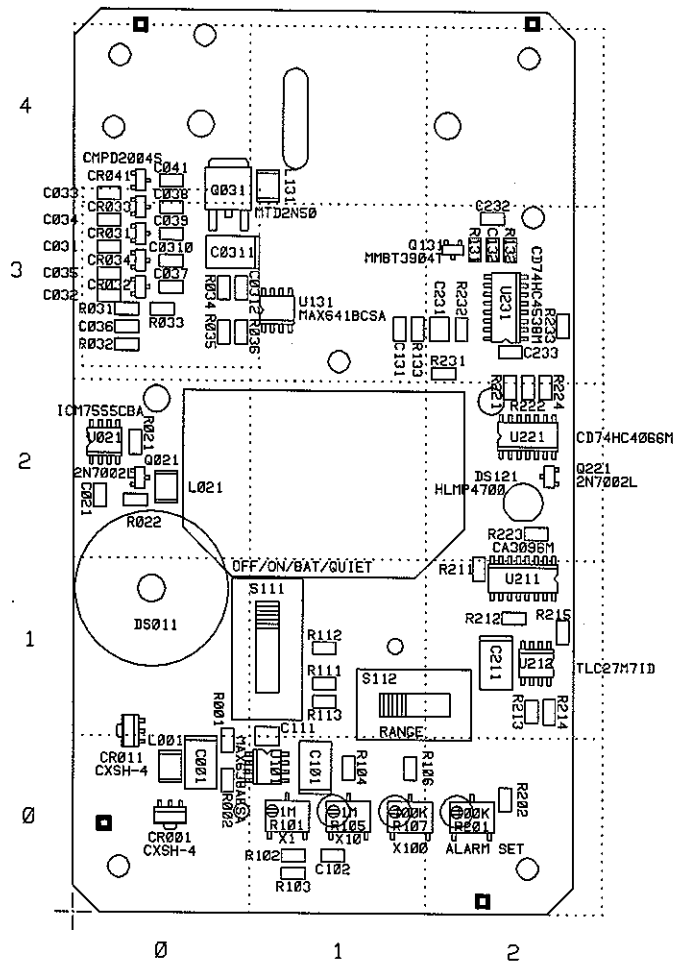

LUDLUM MEASUREMENTS INC. SHEETWATER, TX.			
DR	CKB	07-DEC-03	TITLE: MAIN BOARD
CHK	/	/	BOARD# 5397-190 BS397190
DSGN	RSS	20-AUG-97	MODEL# 2401PA SERIES 397 SHEET 191
APP	<i>KOS</i>	<i>100-100</i>	COMP ARTWORK <input type="checkbox"/> SLDR ARTWORK <input type="checkbox"/>
11:24:11	20-Dec-03	COMP OUTLINE <input checked="" type="checkbox"/>	SLDR OUTLINE <input type="checkbox"/>
COMP PASTE <input type="checkbox"/>		COMP MASK <input type="checkbox"/>	SLDR PASTE <input type="checkbox"/> SLDR MASK <input type="checkbox"/>